



Carol Fox Park

City of Jersey Village

Agenda

1. Goals
2. History of the Park
3. Site Analysis
4. Site Plan Concept
5. Site Plan Details



Goals for Discussion

1. Receive feedback for potential site improvements
 - a. Donor appreciation and park history
 - b. Action plan for existing sidewalks
2. Set action items for Founder's Day
3. Spread the word to founders and surrounding community



Park History

1972

Land between Acapulco Drive and Jersey Drive zoned as park land and called **Senate Avenue Park**

1992

The park was renamed **Carol Fox Park** in honor of the lifelong commitment Carol Fox made to the City of Jersey Village.

2024

Carol Fox Park was enhanced with fencing thanks to crowd fundraising and volunteer efforts by community members. The park now features a ship-themed play structure, gazebo, volleyball court, bathroom facilities, and walking path.



Existing Site Analysis

SHIP PLAY
STRUCTURE
AND SWINGS
AGE: 5-12 YRS



EXISTING PLAY
STRUCTURE
AGE: 5-12 YRS



SAND PLAY AREA
AGE: 2-5 YRS



GAZEBO



Existing Site Conditions



Tree Protection



Existing Sidewalk



Connectivity and Accessibility



Opportunities for Connections



Existing Sidewalk





SITE PLAN CONCEPT

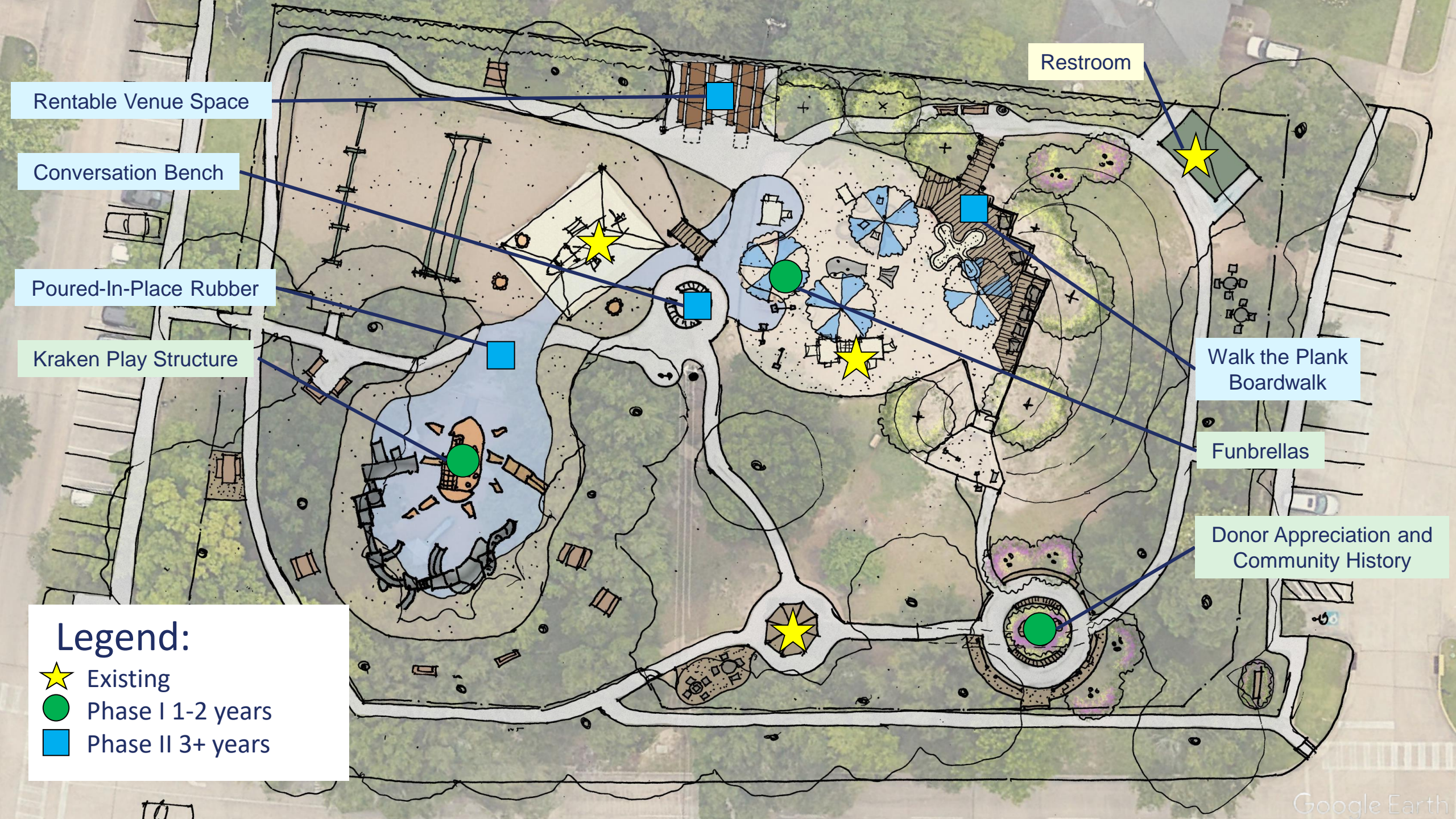

Rentable Venue Space

Conversation Bench

Poured-In-Place Rubber

Kraken Play Structure

Restroom

Walk the Plank Boardwalk

Funbrellas

Donor Appreciation and Community History

Legend:

- ★ Existing
- Phase I 1-2 years
- Phase II 3+ years

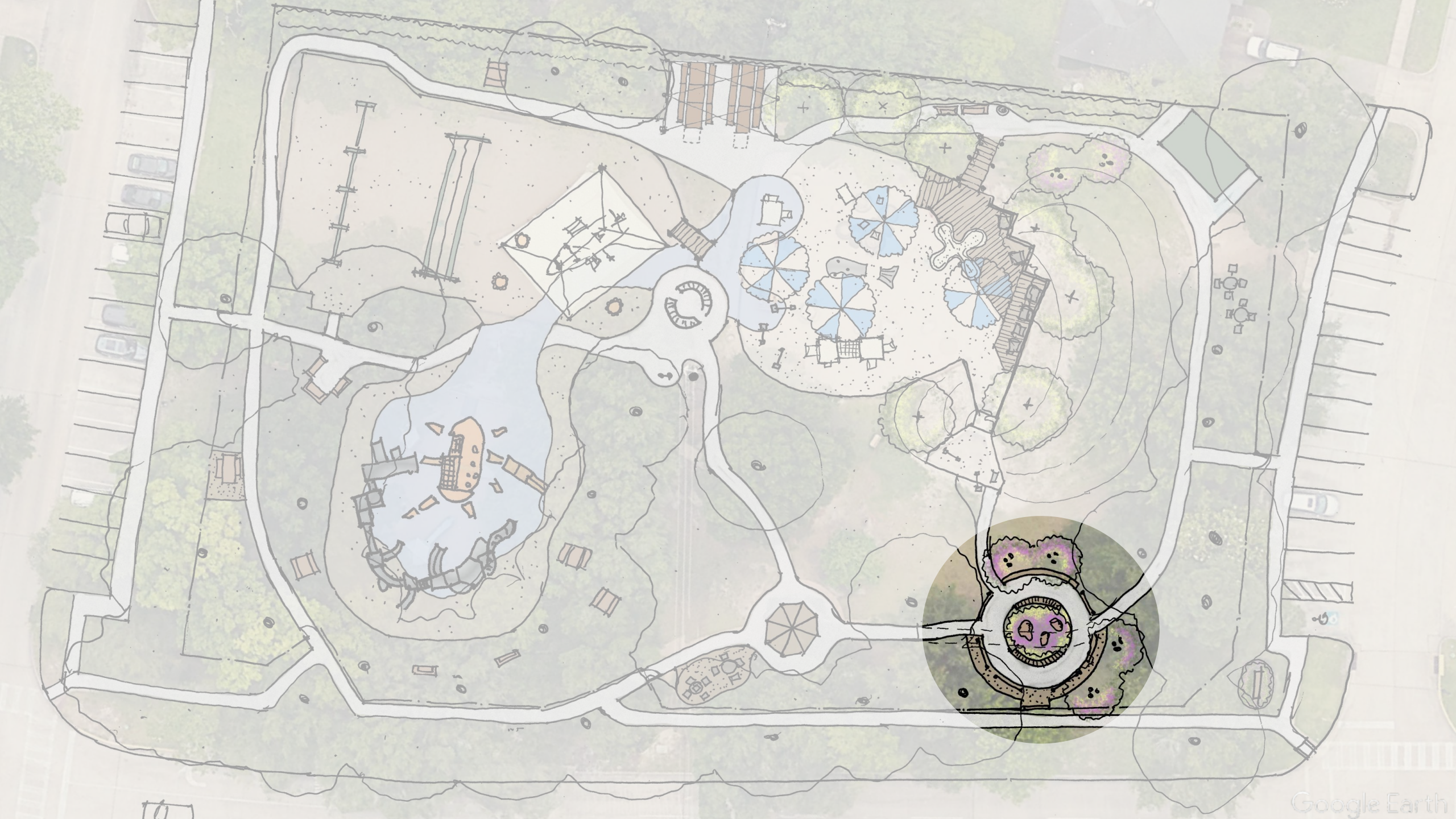

Donor Appreciation and Community History

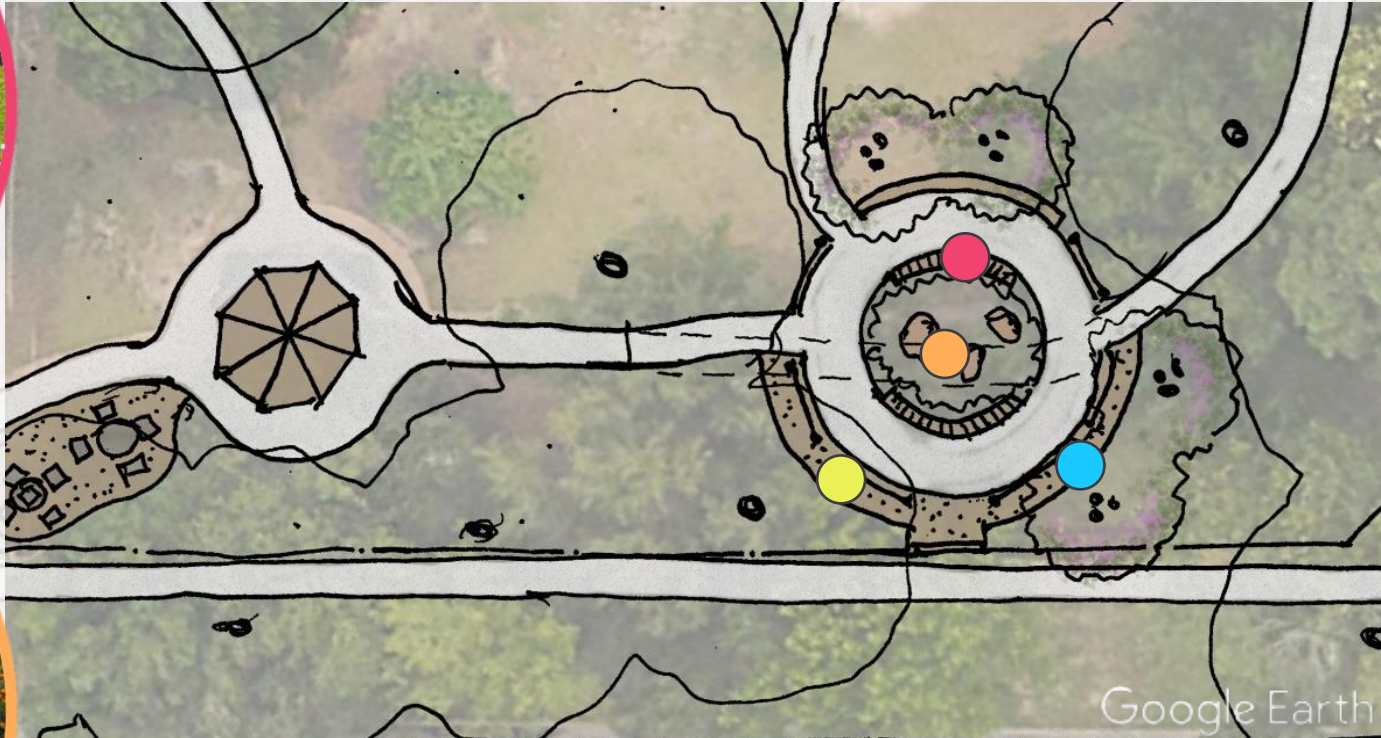

Donor Appreciation and Community History

Photograph Panels



Nature-Inspired Mounted Plaques



Source: Matthew Williams Design and Noll & Tam
Chris Noll, Jessi Tam, Scott Salge, and Trina G...

Donor Birds



Moveable Engraved Plaques



Granite Monument



Source: <https://tombir.com/portfolio/outdoor-displays/>

Donor Pavers





Kraken Play Structure

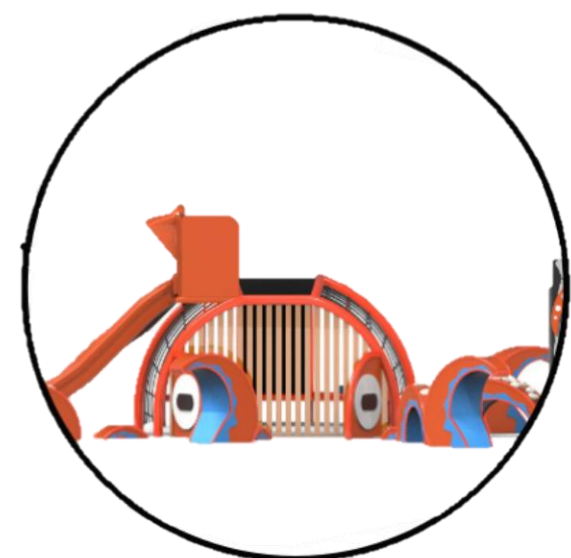
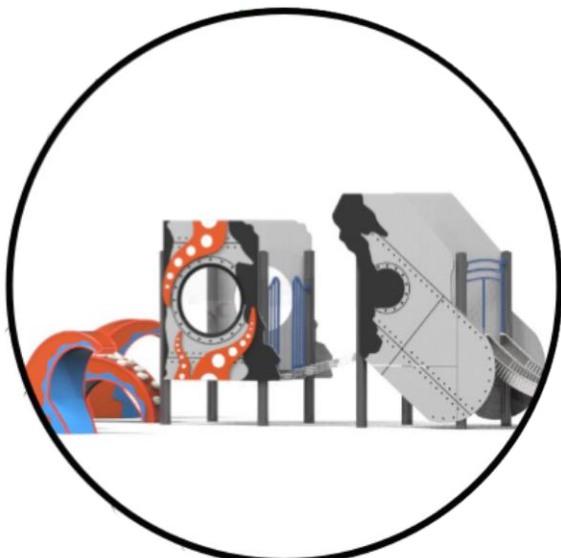
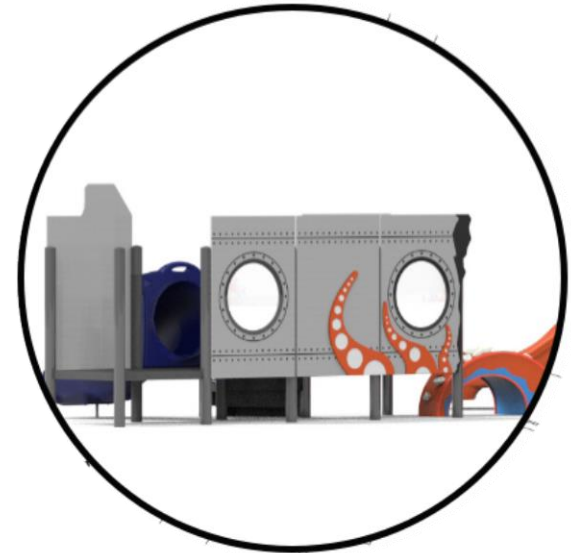
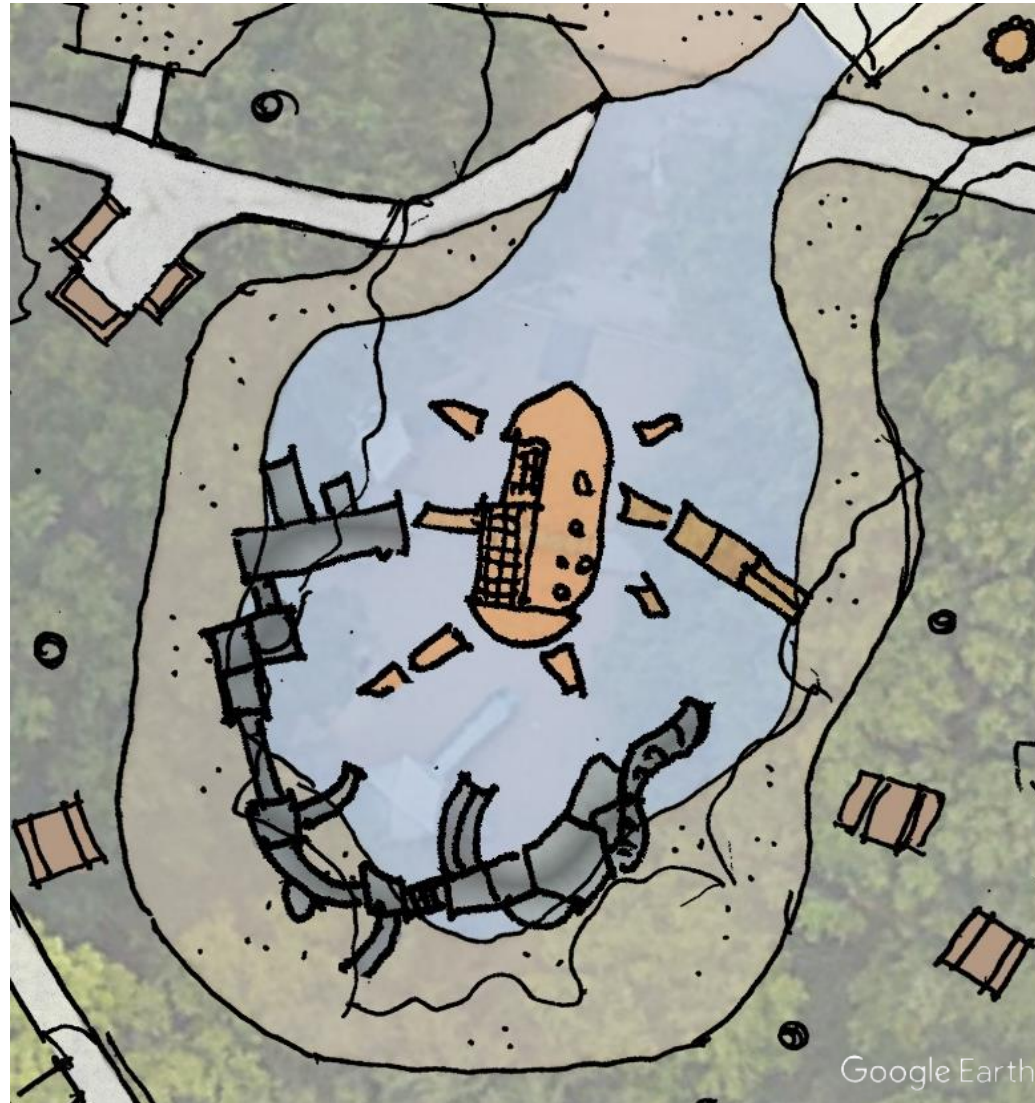

SUBMARINE WRECK

GREY-WHITE
HDPE PANELS

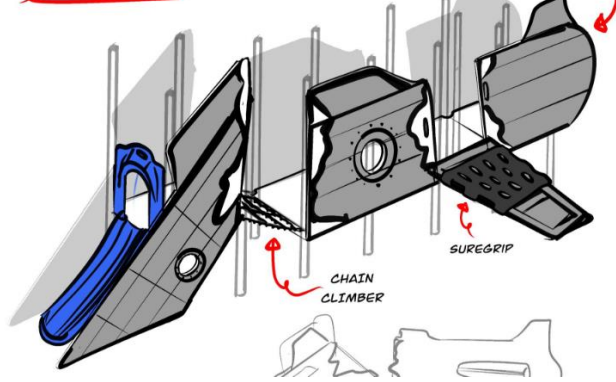

TOPVIEW

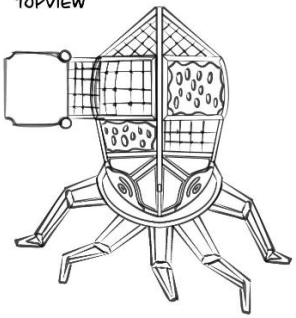

Top view

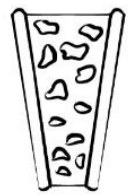
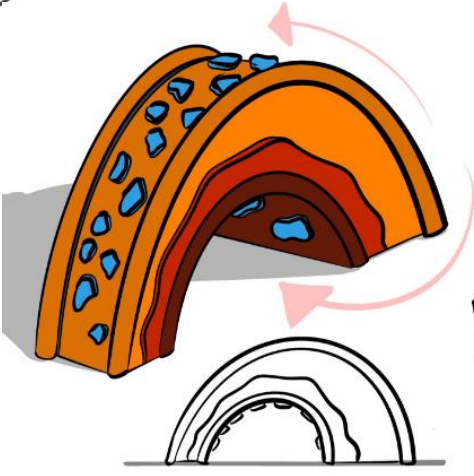
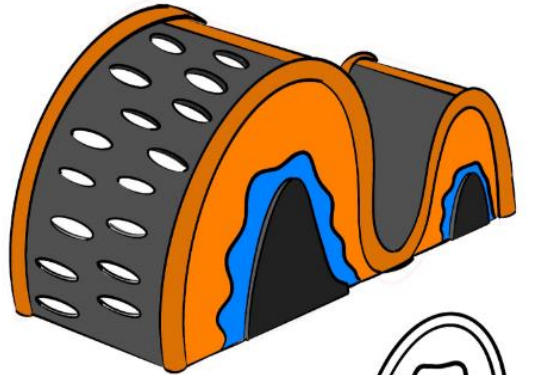
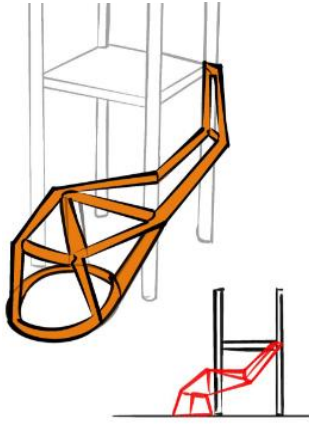
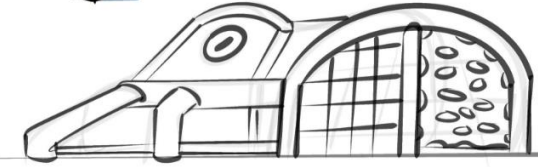
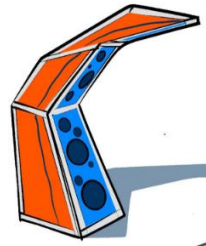
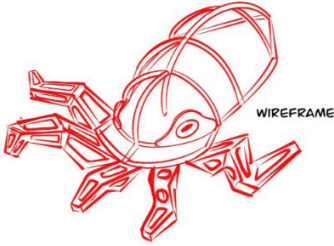
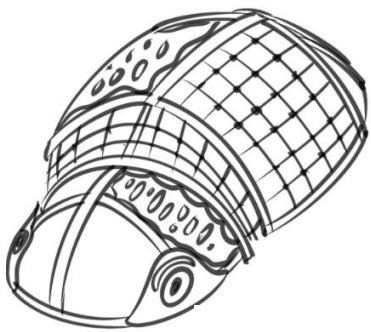
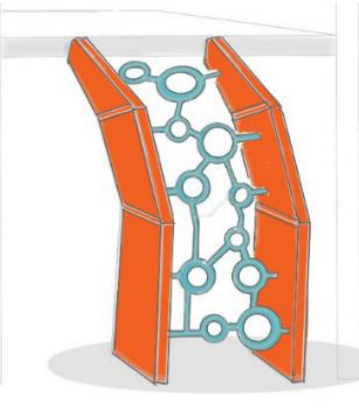
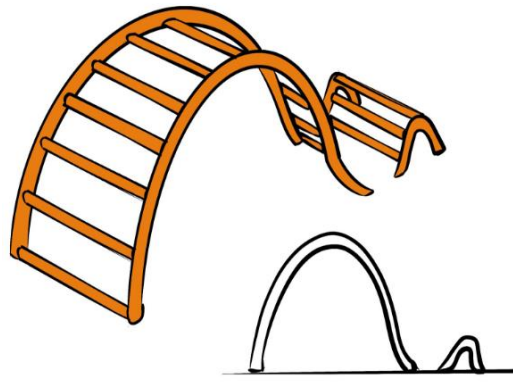
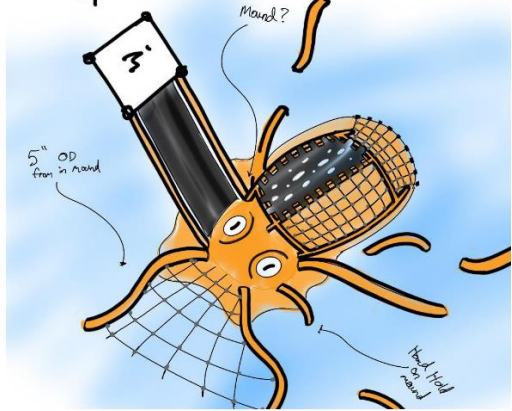

Tentacle Climber Concepts

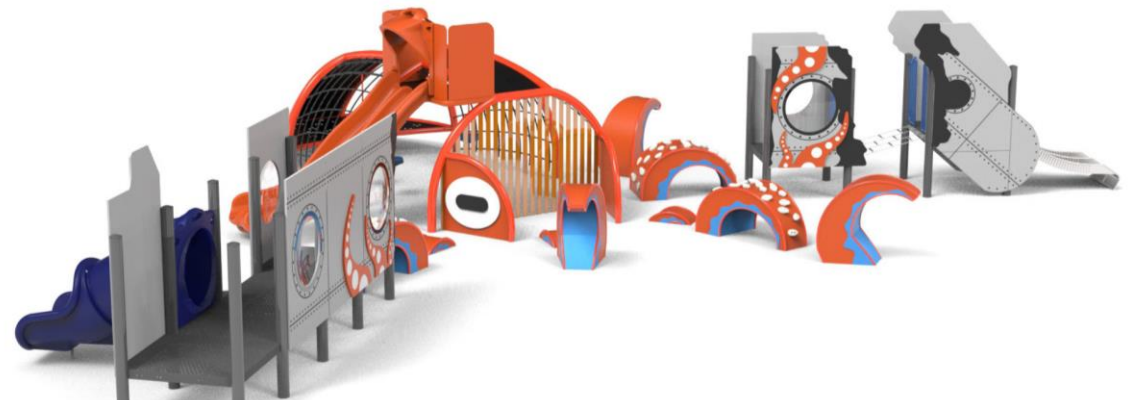
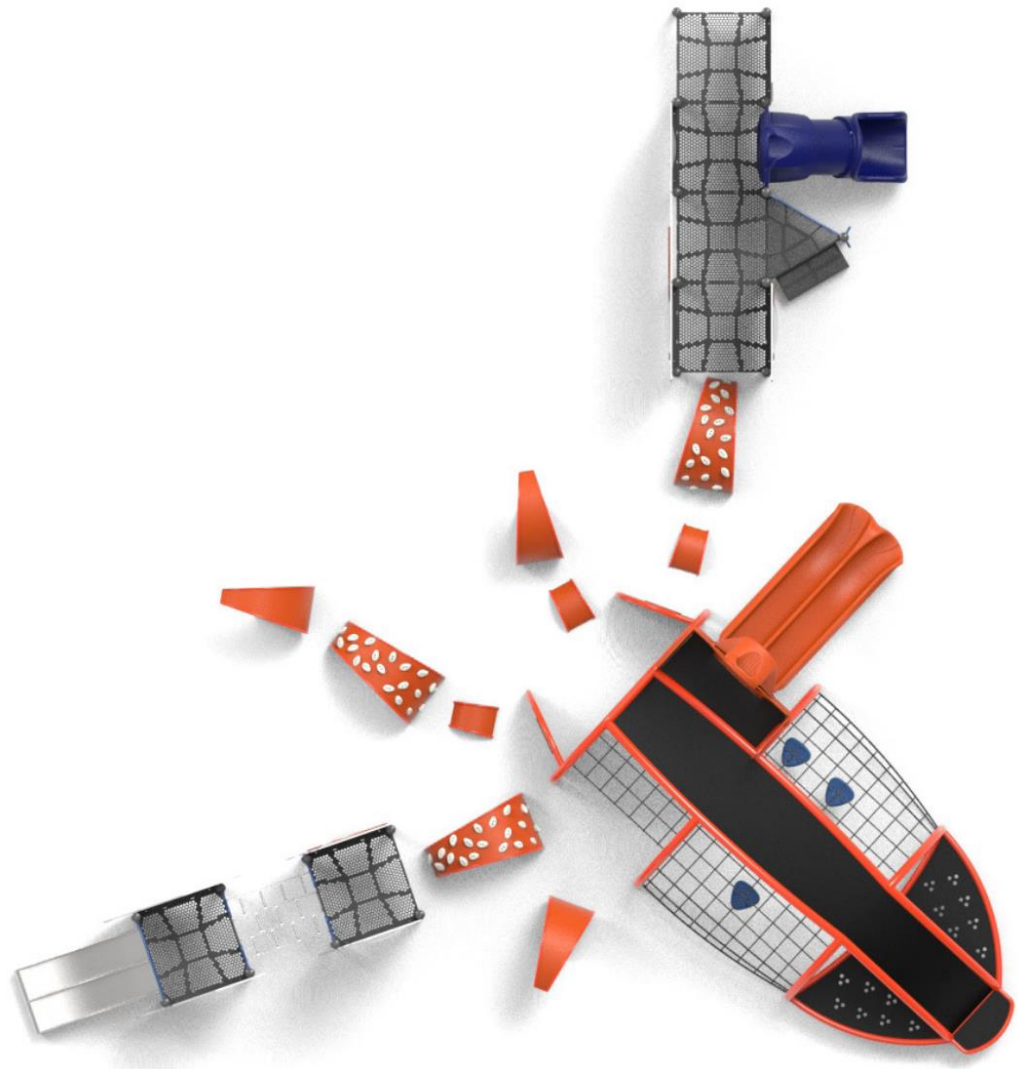

Kraken

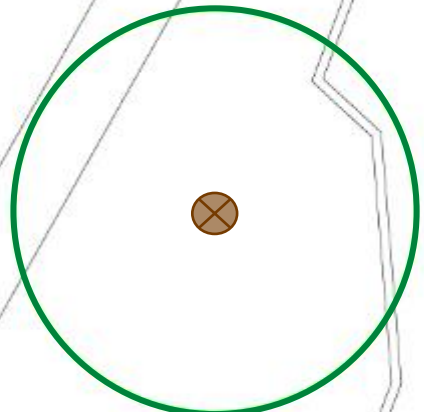
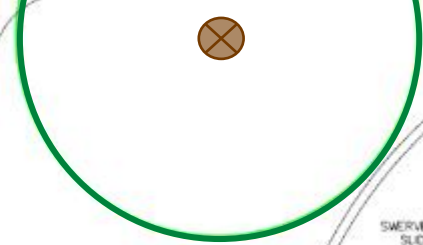
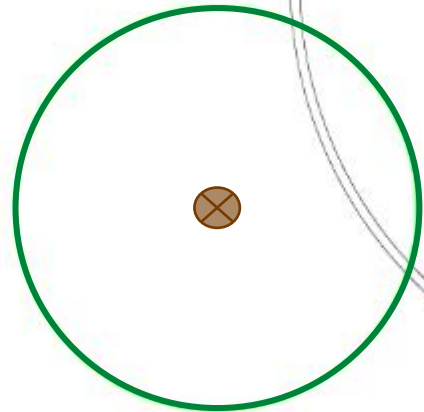
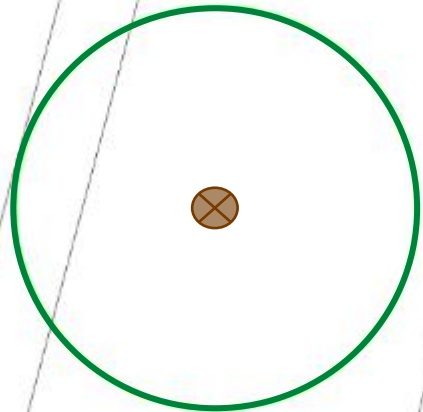
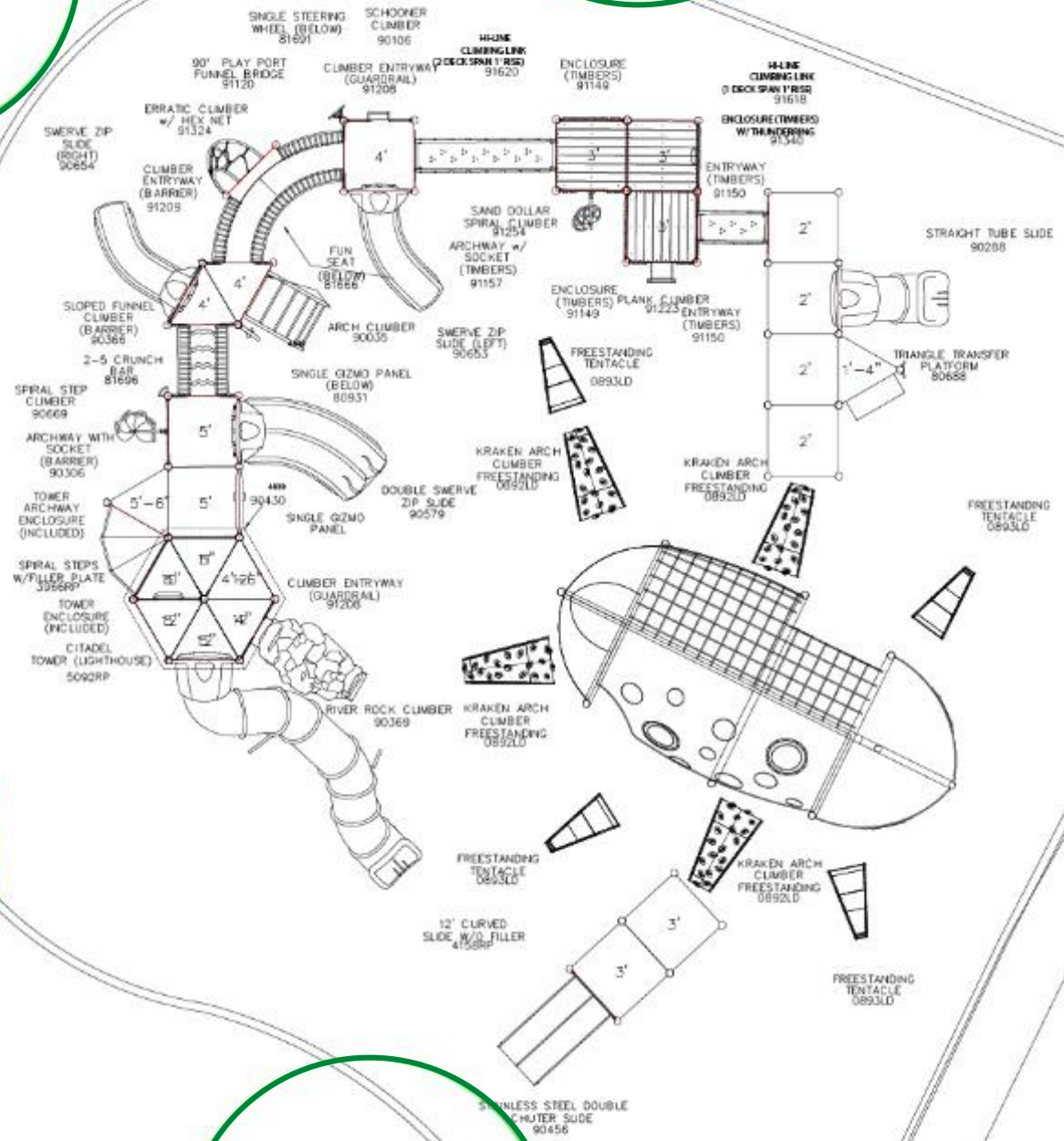



10

Ship Play Structure and Swings

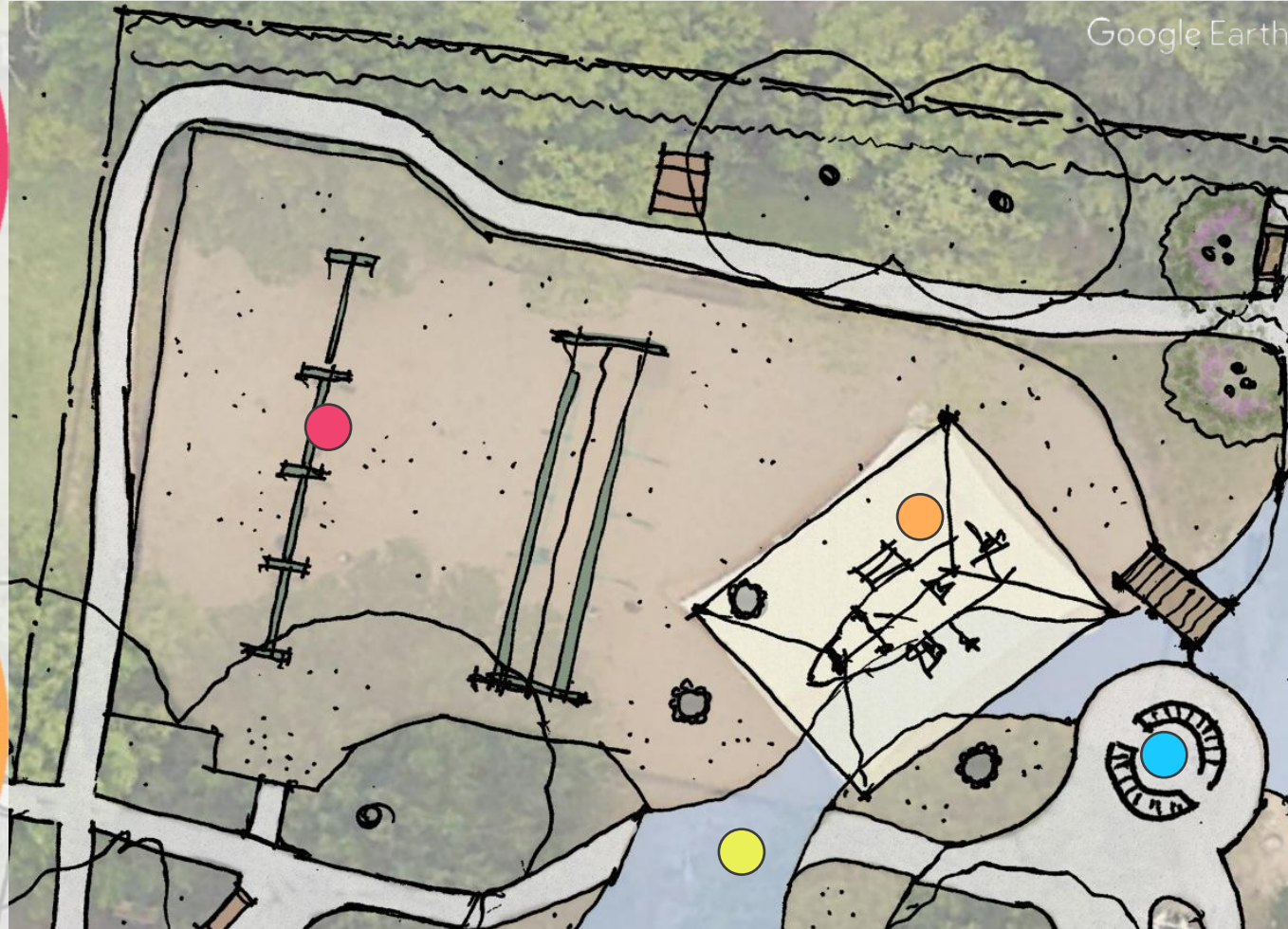



Beach Themed Sand Play Area



Shade Options

Funbrellas (20')



Match Existing Shade Structure



Source: [Funbrella®](https://www.anchorinc.com/) Shade Structures | Anchor Industries ([anchorinc.com](https://www.anchorinc.com/))

Representation of Future Mural





Additional Community Space

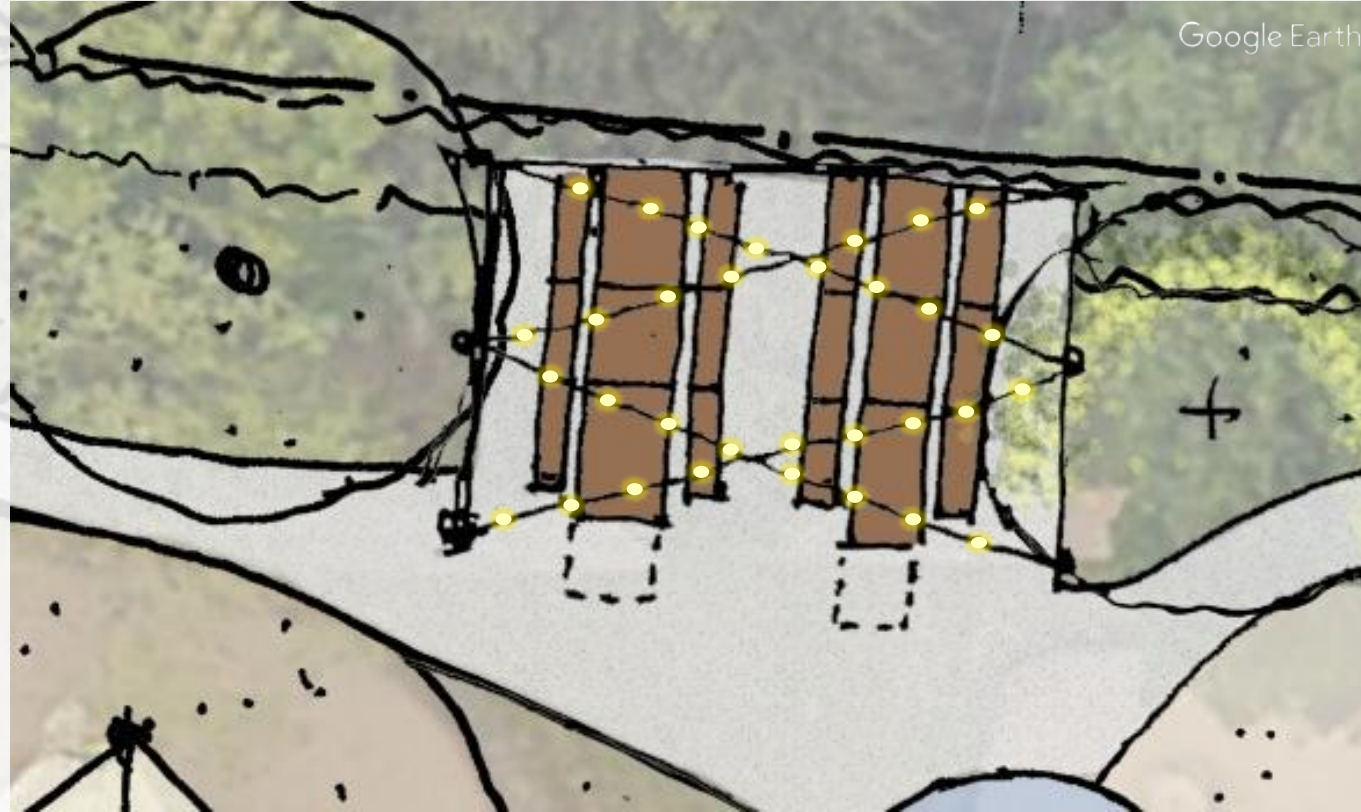

Lighting Options

Existing Light Poles



Security Lighting

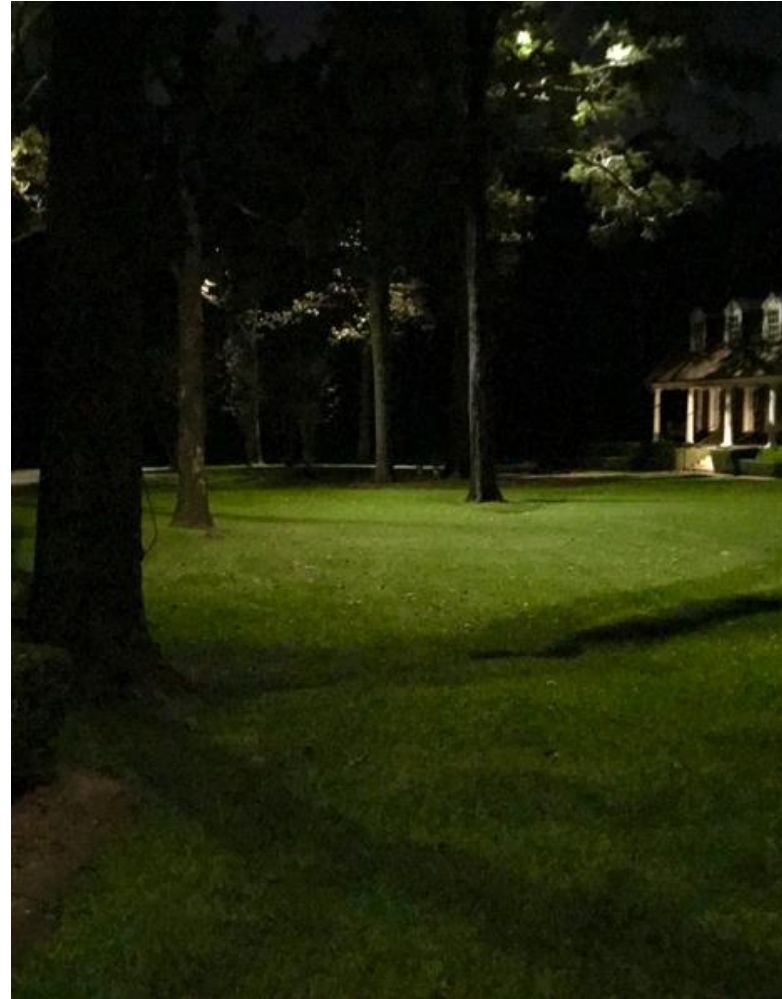

Open Overnight Lighting

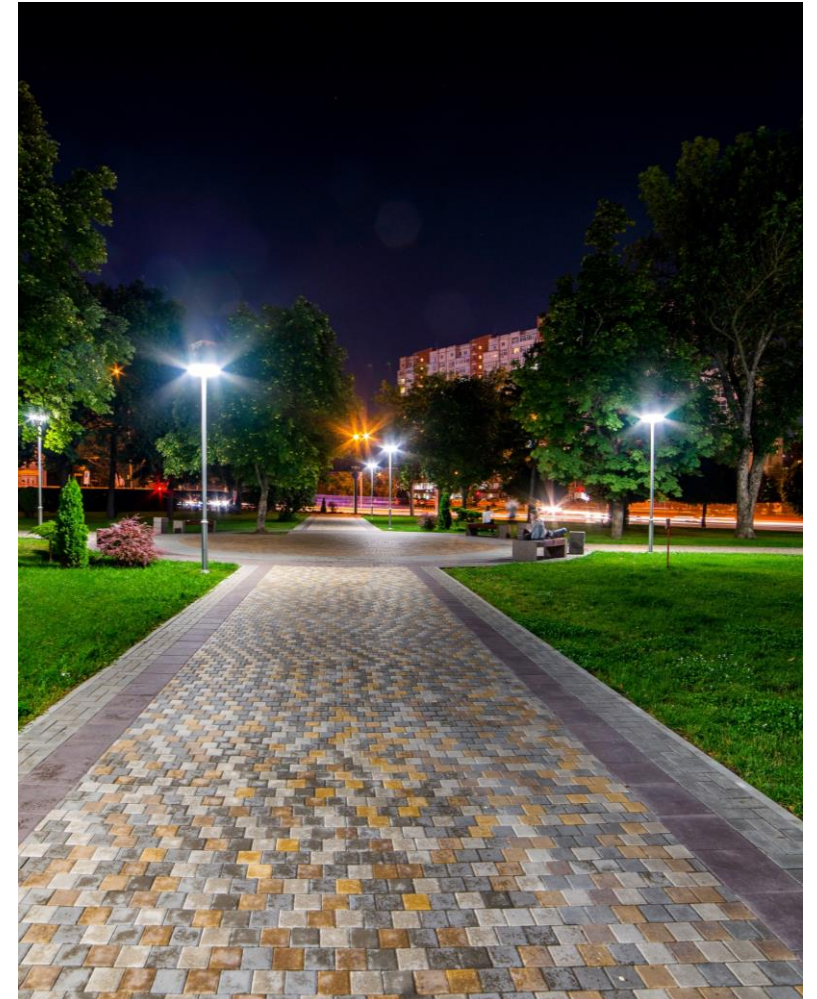

Source: [The Benefits of Moonlighting for Your Outdoor Space - The Lighthouse Group \(lighthouse-lights.com\)](https://www.lighthouse-lights.com)

Phase I:
1-2 Years

Questions?

Phase II:
3 + Years





Thank You